

## Smart Cleaner SC P/N: SCK-SC-250 Instruction Manual

Thank you for choosing the **Smart Cleaner SC**. The **Smart Cleaner SC** is a high-performance device designed for cleaning the ferrule end faces of **SC**, **ST** and **FC** connectors with **UPC** and **APC** polishes. Please carefully read these instructions before using this device. Please keep the instructions for future reference.

### 1. Safety Precautions

	Though our device is deemed safe, improper usage or handling can still inflict injury to others.
	The Smart Cleaner SC is designed to clean SC connectors, ST connectors and FC connectors only. SENKO is not liable for damage caused in attempt to apply this device to other applications.

### 2. Notes on Usage

- Do **NOT** attempt to disassemble as this can cause damage to the device and void the warranty.
- Do **NOT** try to re-use the cleaning cloth as this will eliminate the cleaner's effectiveness and void warranty.
- Do **NOT** touch the cleaning cloth as this will cause contamination.
- Do **NOT** pull the cleaning cloth, use only the device body.
- Do **NOT** use this cleaner when the cloth is empty. This may cause damage to the connector.

### 3. Notes on Storage for Extended Periods





Do not leave the cleaner exposed to direct sunlight, high temperature or high humidity over an extended period. The dust cap should be closed at all times when device is not in use.

### 4. Sales enquiries

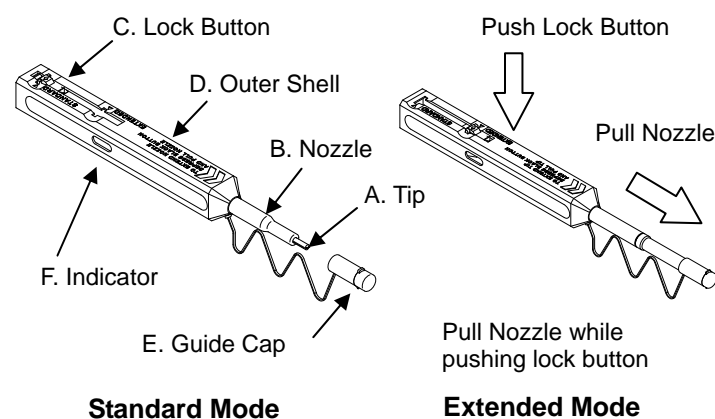
SENKO Advanced Components 225 Cedar Hill St. Marlborough, MA 01752 USA  
 Tel : 508-481-9999 Fax : 508-481-7676 Toll Free : 1-888-32-SENKO  
 E-mail : smartcleaner@senko.com Website : www.senko.com

### 5. Cleaner construction

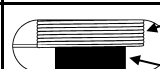

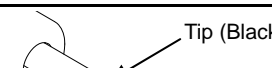
	View of Indicator	View of the Nozzle end
Full	 Cloth (White)	 Tip (Black)
Little	 Cloth (White) Red	 Cloth (White)
Empty	 Red	 Tip (Black) No Cloth (Black)

**Identification of remaining cloth**

No.	Part Name	Function
A	Tip	Lead the cleaning cloth to the optical connector end face.
B	Nozzle	Lead tip to the optical connector end face.
C	Lock Button	Push the button to extend and contract the nozzle.
D	Outer Shell	Push the outer shell to clean the connector.
E	Guide Cap	Acts as dust cap or cleaning adapter for connector plug.
F	Indicator	Provides indication of remaining cleaning cloth.

## 6. Applications

### Connector inside adaptor

1. Remove Guide Cap from the device.

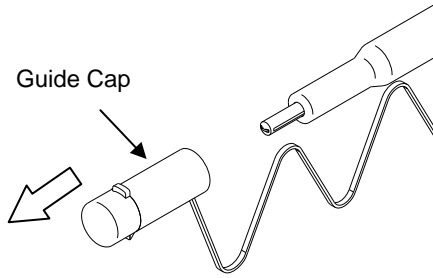

2. Insert tip of cleaner into SC Adaptor.

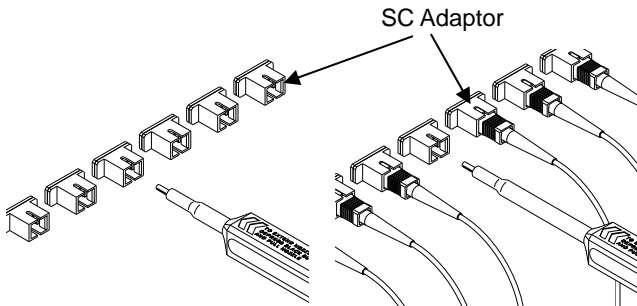

**Standard**

**Extended Mode**

**Note:** This drawing shows only SC, but this product can clean ST and FC.

3. Push the Outer Shell to start cleaning the SC connector end face. A "pop" sound indicates end of cleaning process. Close the cover after use.

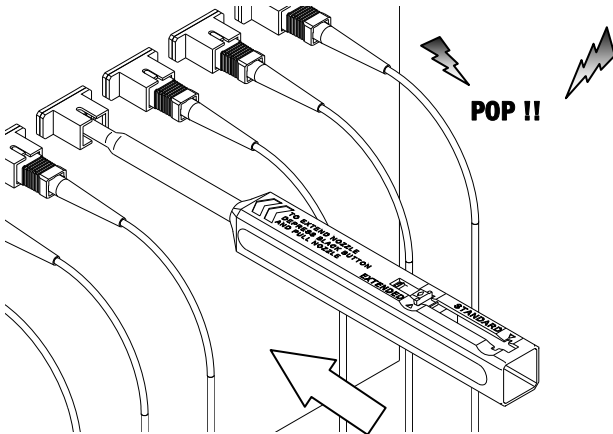

Be careful not to slant the Smart Cleaner SC while inserting into the adaptor.

Do not overly exert force during insertion as this may cause damage to both the connector and the Smart Cleaner SC.

If pushing Outer Shell is inhibited, remove the Smart Cleaner SC from adaptor and ensure that there is no sizeable debris inhibiting the cleaning process.

### Connector plugs alone

1. Open the Cover on the Guide Cap.

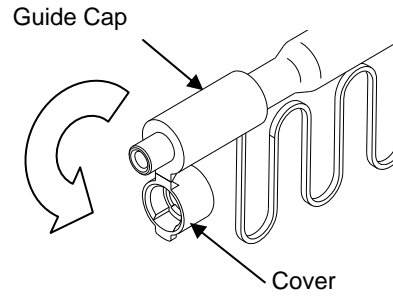

2. Insert SC connector into the Guide Cap.

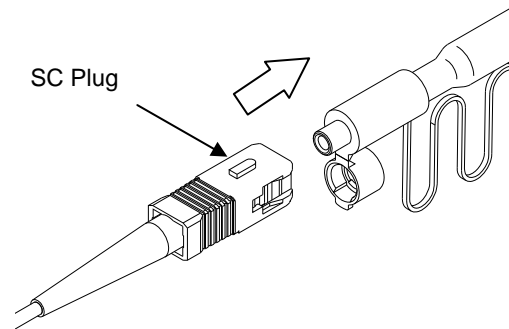

**Note:** This drawing shows only SC, but this product can clean ST and FC.

3. Push the Outer Shell to start cleaning the SC connector end face. A "pop" sound indicates end of cleaning process. Close the cover after use.

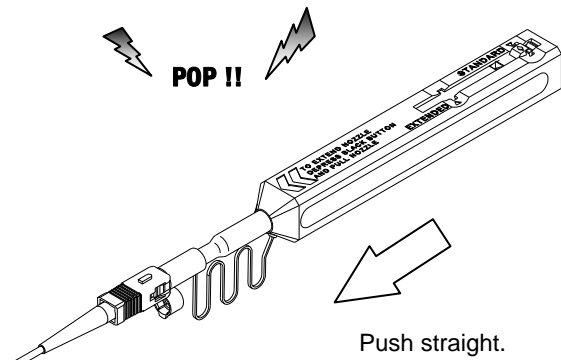

Be careful not to slant SC connector while inserting into the Guide cap.

Do not overly exert force during insertion as this may cause damage to both the connector and the Smart Cleaner SC.

If pushing Outer Shell is inhibited, remove the Smart Cleaner SC from adaptor and ensure that there is no sizeable debris inhibiting the cleaning process.