

XP FIT PLUS LC CONNECTOR Series 951

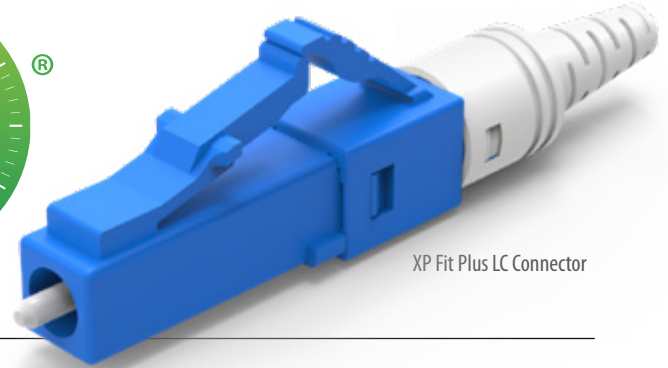

XP Fit Plus LC Connector

The XP Fit Plus™ is a pre-polished, pre-assembled connector compatible with the standard LC connector. In place of epoxy, an internal mechanical grip gently but effectively holds the fiber in place and can be installed in under two minutes. Without polishing or adhesives, the XP Fit Plus makes field installations quick and easy, eliminating the need for epoxy curing and hand polishing at the work site.

FEATURES

- Pre-polished, pre-assembled
- Internal mechanical splice (*index matching gel*)
- Single-mode and multimode options
- Highly stable and reliable
- Suits multiple cable types
- IEC compliant

APPLICATIONS

- Field applications.
- Telecommunications
- Data centers
- Local area networks (LANs)
- FTTX networks
- Premise distribution networks
- Industrial applications

KEY BENEFITS

- ✓ **Simple termination, no adhesives, no polishing**
- ✓ **Does NOT require the use of a fusion splicer**
- ✓ **High quality matching gel**
- ✓ **Quick installation**
- ✓ **Multiple cable suitability**
- ✓ **Color coded housings**

Mechanical Data

	Value
Durability	500 matings
Cable Types	900 μm, 2 mm, 3 mm
Intermateability	LC (IEC 61754-20)
Polishing	PC / APC
Fiber Count	Simplex (1 Channel)
Tensile	TIA.EIA 568-C.3

Optical Data

	Singlemode		Multimode
	PC	APC	PC
Typical Insertion Loss (dB)	0.2	0.3	0.1
Typical Return Loss (dB)	50	60	35

Environmental Data

	Value
Operating Temperature	-40°C to +75°C
RoHS Compliance	Yes
REACH Compliance	Yes
Humidity Resistance	95%

Connector Drawing

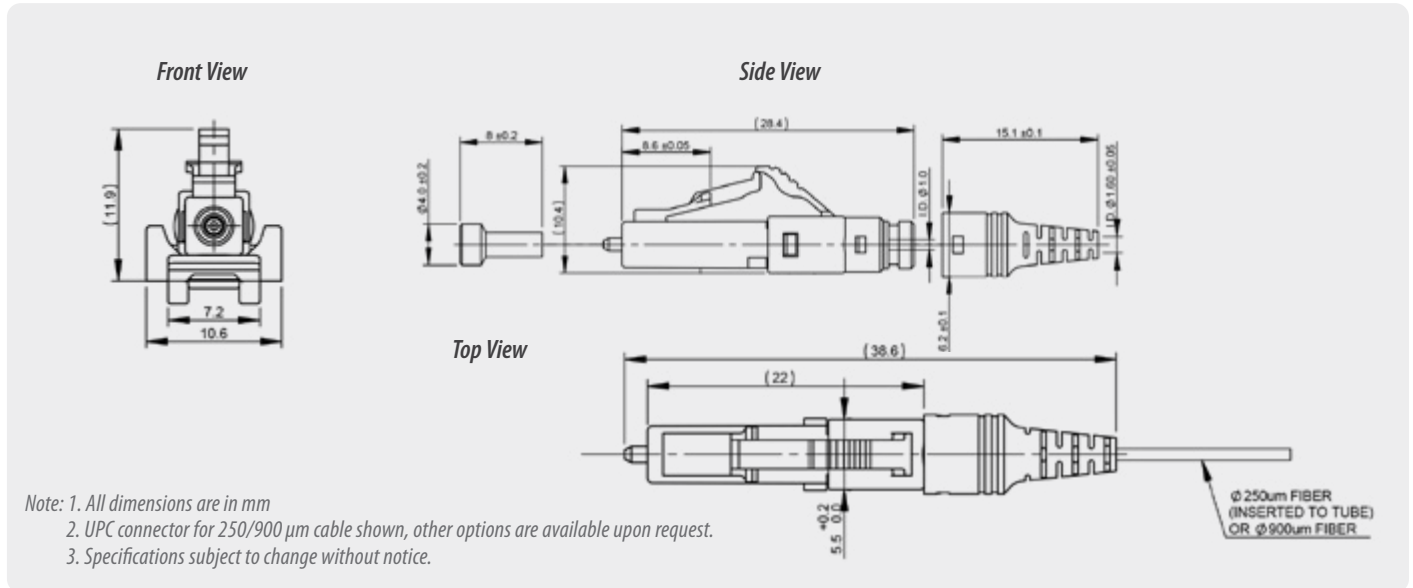

ORDERING

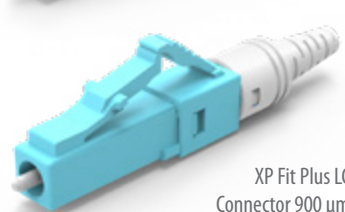
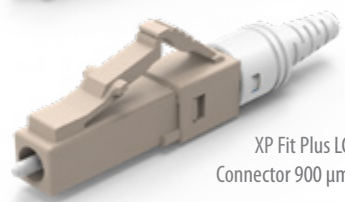
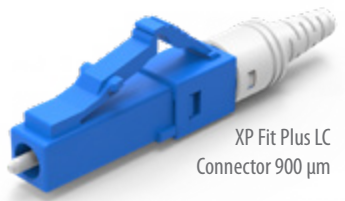

PART NUMBER	DESCRIPTION	HOUSING	BOOT COLOR
951-191-111	XPFit Plus SC Connector SM: PC 900 μm/250 μm 120pack*	Blue	White
951-291-411	XPFit Plus SC Connector SC: APC 900 μm/250 μm 120pack*	Black	White
951-391-211	XPFit Plus SC Connector MM: 50/125 900 μm/250 μm 120pack*	Beige	White
951-491-511	XPFit Plus SC Connector MM : 62.5/125 900 μm/250 μm 120pack*	Aqua	White

951-191-111 ORDER CODE example

Note: 1. 12 pack available. Add -12 to existing part number
 2. Typical specification values are at 23°C ±5°C
 3. The connector performance specifications include an internal mechanical splice

Accessories - Production/Cleaning**Smart Cleaner™****Cassette**

PN: SCK-CC-100

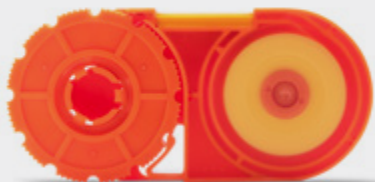
**Smart Cleaner™****Mini 1.25 mm Clicker**

PN: SCK-SS-M-C125

Refill PN: SCK-SS-CS-R

**Smart Cleaner™****1.25 mm Clicker**

PN: SCK-SS-CS

Refill PN: SCK-SS-CS-R

**1.25 mm NEOCLEAN
Cleaning Stick**

PN: CSK-01

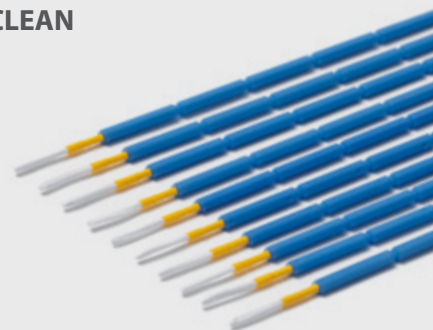
**Accessories - Interferometry****SUMIX Manta W+ Inspection Scope**

PN: SMX-Manta-W+



- Inspects 12 fiber in 2.6 seconds, 24 fiber in 4.5 seconds
- 0.5µm defect detection
- Inspection tips for MPO, CS, SN, LC available

SUMIX Max QM+ Inspection Scope

PN: MAX-Quantum



- Inspects 12 fiber in 2.6 seconds, 24 fiber in 4.5 seconds
- 0.5µm defect detection

SENKO[®]

Advanced Components

sales@senko.com
1-858-623-3300

senko.com/contact