

Optical Return Loss Measurement

Bernard Lee

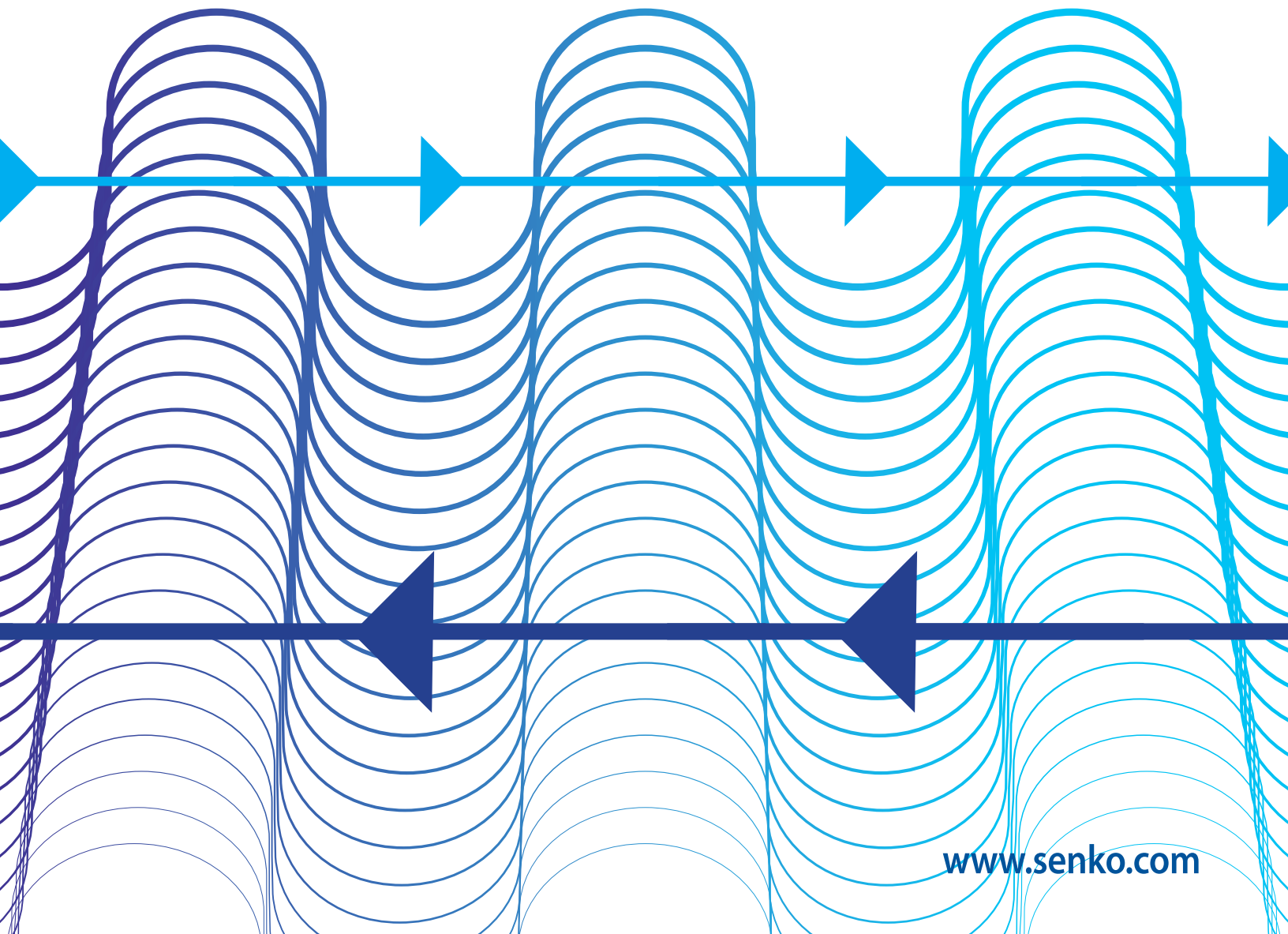

SENKO ADVANCED COMPONENTS, INC.

America

USA EAST 1-888-32-SENKO
USA WEST 1-858-623-3300
TEXAS 1-972-661-9080
Sales-Americas@senko.com

South America

BRAZIL +55-21-3736-7065
Sales-Brazil@senko.com

Asia

HONG KONG +852-2121-0516
SHANGHAI +86-21-5830-4513
SHENZHEN +86-755-2533-4893
Sales-Asia@senko.com

Europe

FRANCE +44 7939364565
Salesfrance@senko.com
GERMANY +49(0)15117683072
Sales-Germany@senko.com
ITALY +39 338 8919089
Sales-Italy@senko.com
POLAND +44 (0) 7796444488
Sales-Europe@senko.com
SPAIN & PORTUGAL +34 678042829
Sales-Iberia@senko.com
UK +44 (0) 1256 700880
Sales-UK@senko.com
OTHER +44(0) 1256 700880
Sales-Europe@senko.com

Asia Pacific

AUSTRALIA +61 (0) 3 9755-7922
Sales-Asia-Pacific@senko.com

Middle East North Africa

DUBAI +971 4 8865160
Sales-MENA@senko.com

Japan

TOKYO +81 (0) 3 5825-0911
Sales-Japan@senko.com

www.senko.com

Optical Return Loss Measurement

Contents

4	Executive Summary
5	Causes of Optical Return Loss
6	Optical Time Domain–Based Measurement
7	- Limitations
9	- Measurement Method
10	Optical Continuous Wave–Based Measurement
10	- Limitations
11	- Measurement Method
12	Summary
13	References
13	Biography

Executive Summary

To ensure the proper performance of an optical transmission system, various parameters—such as attenuation and optical return loss (ORL)—must be within the acceptable tolerance levels of both the transmission and receiving equipment. ORL is measured according to the characteristics of components such as cables, patch cords, pigtailed, and connectors as well as on an end-to-end network ORL level.

With increasing data speeds and the use of WDM technology, accurate measurement of ORL is becoming ever more important in characterizing optical networks. ORL is defined as the ratio of light reflected back from an element in a device to the light launched into that element. This is usually represented as a negative number in decibels (dB). The mathematical formula representing ORL is shown below:

$$RL = 10 \log_{10} (PR/P_{in})$$

PR = reflected power **P_{in} = input power**

In addition to the increase in network attenuation, high levels of reflected optical power can cause light-source signal interference, higher bit-error rates (BER) in digital systems, lower signal-to-noise ratios (SNR), laser output power fluctuations, and even—in more severe situations—permanent damage to the laser source. ORL and reflectance must be measured both on the level of the individual component, such as a connector or cable assembly, and on an end-to-end network level.

Higher transmission bandwidth networks require higher ORL performance. For example, an OC-48 2.5 Gbps transmission network has a minimum ORL level of 24 dB, while an OC-768 40 Gbps network has a minimum ORL level of 30 dB. An FTTx network delivering video content with a low BER tolerance has a minimum ORL level of 32 dB. As outlined in the IEC 61300-3-6 standard, there are four primary tools to measure return loss:

- optical continuous-wave reflectometer (OCWR)
- optical time-domain reflectometer (OTDR)
- optical low-coherence reflectometer (OLCR)
- optical frequency-domain reflectometer (OFDR)

The measurement methods are applied depending on the device under test (DUT) condition, level of return loss, measurement distance, and measurement resolution. This paper will focus on the return loss measurement using an OCWR and OTDR.

Causes of Optical Return Loss

Back reflectance is defined as the ratio of reflected optical power to the incident optical power at the input of the device. The term ORL is used to describe the ratio of relative magnitude of the cumulated back reflectance or multiple Fresnel events and backscattered signal power to the optical power at the device's input. There are two primary factors that cause ORL: Fresnel backreflection and Rayleigh backscattering.

Fresnel backreflection

Fresnel backreflection occurs in different network elements where there are transitions through different media. Optical connectors are especially prone to reflections because of air gaps, impurities, geometry misalignments, and manufacturing imperfections. Other common sources of Fresnel backreflection are mechanical splices, open fiber ends, and cracks in the optical fiber. Significant light is backreflected to the source when light travels from the fiber core to air. In ORL sensitive networks, angle-polished connectors (APC) are usually deployed to reduce backreflection to the source.

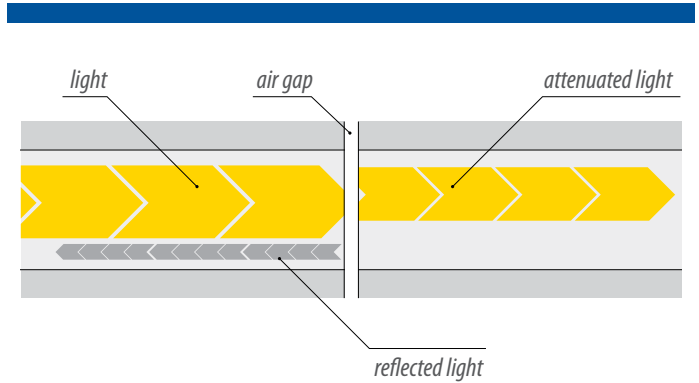

Rayleigh backscattering

Rayleigh backscattering is an intrinsic property of optical fiber that causes light to scatter. This is usually caused by defects and impurities introduced into the fiber core during the manufacturing process or by regions under mechanical stress, such as microbending. A fraction of the scattered light directed back to the source is detected as ORL, while the majority of scattered light will be lost. Rayleigh scattering occurs along the total length of fiber. The magnitude of backscatter depends on fiber type, transmitted optical power level, and optical wavelength. The transmission distance will also affect the backscatter level: the longer the fiber network, the greater the backscattering. This property can be calculated and is an important parameter to consider when setting up test equipment, such as an OTDR.

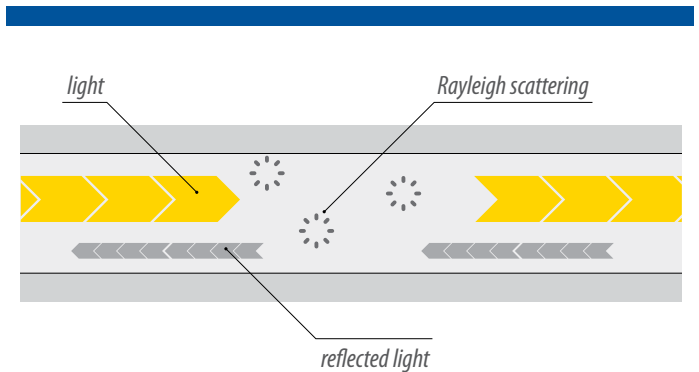

Backreflection VS Length (10m singlemode)

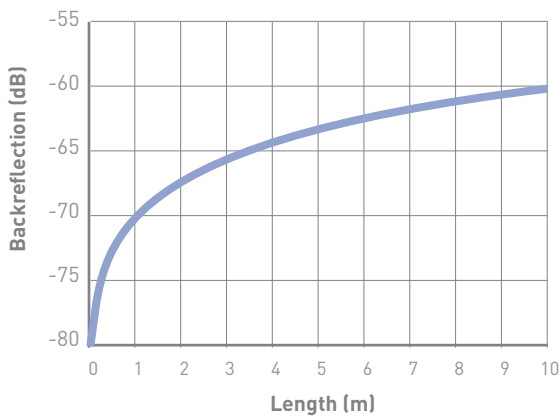

Backreflection VS Length (100m singlemode)

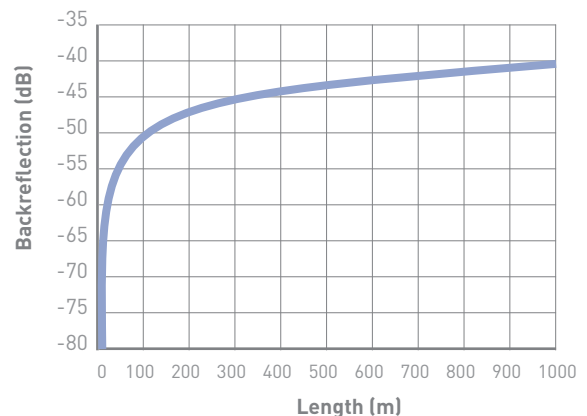

Optical Time Domain–Based Measurement

Overview

Optical time domain–based measurement spatially evaluates backreflection characteristics both in individual components and along the length of a fiber. One main instrument that uses this measurement method is the optical time-domain reflectometer (OTDR). An OTDR measures the backscatter level of the fiber medium itself and the peak reflection level of Fresnel events along an optical link. The backscatter measurement level is a function of the fiber backscatter coefficient—an intrinsic factor of the fiber under test—and the pulse width used for measurement.

As its name suggests, an OTDR operates in the time domain and measures the backscatter optical-power level from the fiber itself. It enables users to measure Fresnel backreflection at any point along the fiber under test without de-mating optical interconnections. A light pulse is introduced into an optical link and will experience both backreflection and Fresnel events along the pathway. The power level of light reflected back to the source is measured with reference to the time it takes for the light to return to the source. In this way, the

OTDR estimates the distance of an event from the source according to the elapsed time versus the speed of light. This makes the OTDR a very useful tool in evaluating the distance of the optical network under test as well as the location of components in the network, thus enabling the tester to evaluate the network for commissioning purposes and locate network faults for maintenance.

There are two types of OTDRs: the photon-counting OTDR (PC-OTDR) and the network OTDR. Although both types of OTDR use the same principles to measure ORL, the PC-OTDR applies a much shorter optical pulse width, enabling a much higher spatial resolution and reflection sensitivity. However, this reduced dynamic range lowers the maximum useful DUT length of a PC-OTDR. Due to these differences, the two types are applied for different purposes: network OTDRs are typically portable and usually deployed in outside plant networks for commissioning and troubleshooting, while PC-OTDRs are usually used for qualification and troubleshooting of individual components, modules, or subsystems in which reflections are often closely spaced.

	Max Spatial Resolution	Reflection Sensitivity	Reflectance Measurement Range	Optical Pulse Length	Max Length of DUT
Network OTDR	> 1 m	–60 dB	≈ 50 dB	≥ 10 ns	< 100 km
PC-OTDR	≈ 10 mm	< –120 dB	≈ 60 dB	≤ 10 ns	< 200 m

Limitations

Backscatter Coefficient Settings

As OTDRs measure backreflection power levels, the reflectance of a given element in the DUT depends on the fiber backscatter coefficient, optical pulse width, and the measured reflectance amplitude with reference to the backscatter level. An inaccurate backscatter coefficient value setting can lead to an error in measuring reflection level. The percentage of measurement uncertainty increases with a lower reflectance value.

The backscatter coefficient is usually one of the parameters that is set when performing an OTDR measurement. In a fiber-access network, especially one that has legacy fibers, there may be a combination of various fiber standards – for example from early G652.A fiber to G657.A2 fiber – as well as fiber from different suppliers manufactured with different methods, such as the plasma chemical vapor deposition (PCVD) method or the modified chemical vapor deposition (MCVD) process. The OTDR's backscatter coefficient setting cannot be adjusted to match the varying fiber characteristics in the network under test.

Index of Refraction (IOR)

IOR is a way to measure the speed of light in a medium with reference to the speed of light in a vacuum, where light moves fastest. Light travels at approximately $3 \times 10^8 \text{ ms}^{-1}$ in a vacuum. The IOR of a medium such as an optical fiber core is calculated by dividing the speed of light in a vacuum by the speed of light in the medium. By definition, the IOR of light in a vacuum is denoted by 1. A typical single-mode fiber has a silica-doped core with an IOR of approximately 1.447. The larger a medium's IOR value, the more slowly light travels in that medium.

An inaccurate IOR setting in an OTDR will cause the total distance of the network measured to be skewed. If the IOR is set too high, the OTDR will calculate the network distance to be shorter than it actually is; likewise, if the IOR is set too low, the OTDR will measure too long a distance. A difference in IOR setting of just 0.01 can cause a reading difference of 70 m over a 10 km fiber span. When an OTDR is used to locate a specific fault in a network, an incorrect IOR setting can cause the fault location shown in the OTDR to be far off from the actual location.

Excessive Loss

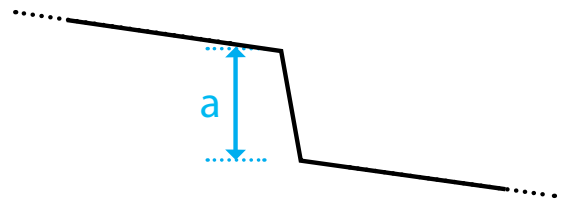

Gainer



IL

$$\text{Insertion Loss} = \frac{a + b}{2}$$

Limitations

Dead Zone

A dead zone is the location of a section of network beyond a reflective event, where subsequent network characteristics cannot be measured. There are two types of dead zones: attenuation dead zones (ADZs) and event dead zones (EDZs).

An ADZ is the minimum distance required to make an attenuation measurement for an event. This value is usually defined as the distance between the rising edge of a reflective event to the 0.5 dB deviation from a straight line fit to the optical backscatter level. The optical backscatter level is the sloping line that indicates the fiber attenuation over distance.

An EDZ is the minimum distance required for the OTDR to detect two separate events. This is usually defined as the distance between two cursor points set at 1.5 dB below a reflective peak, where the peak is non-saturating.

Dead zone measurement depends on the pulse width and the network element reflectance level. A shorter pulse width will result in a shorter dead zone, while a connector with a high return loss will result in a longer dead zone. When testing a long-distance network, testers will use a higher pulse width, thus increasing the length of the dead zone. This can cause multiple nearby events to be identified as a single merged event. Examples include the connector and splice of a pigtail as well as both connector ends of a patch cord.

Most OTDR manufacturers specify the OTDR dead zone for the shortest pulse width and optimal connector reflectance. However, this specification cannot be taken at face value. The suitable pulse width to be used for network measurement usually depends on the total length of the network, while individual components within the network have variable reflectance performance due to manufacturing quality and hygiene.

Helix Factor

OTDRs are widely deployed in testing and measurement of outside-plant optical fiber networks. In an outside-plant environment, optical fibers are deployed in cables. The most common cable types deployed are loose-tube cables and slotted-core cables. Optical fibers within these cables are not strung in a straight line but spiral around a central strength member in an "SZ" fashion within loose tubes.

As light from an OTDR travels through the optical fiber, OTDRs measure the optical fiber distance rather than the cable distance. Depending on the helix factor of a cable—which can range from 0.3% to 42%, depending on the cable design—a cable 700 m long may comprise 1,000 m of fiber distance. Without an accurate measurement of the helix factor, fault locating by using an OTDR may result in considerable discrepancy. Most modern OTDRs have a helix setting to adjust the distance measurement.

Attenuation deadzone definition

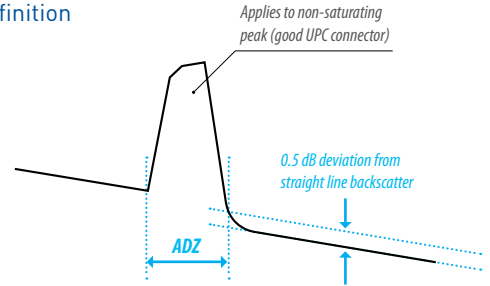

Event deadzone definition

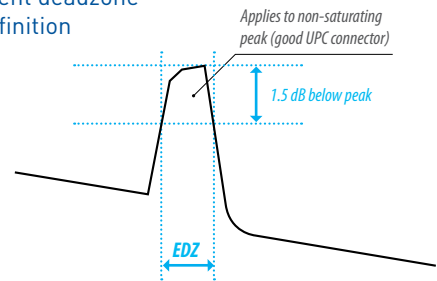

Attenuation deadzones of two concatenated connectors

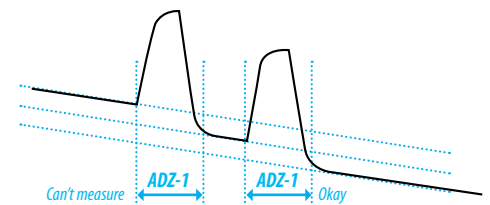

Attenuation deadzones of two concatenated connectors

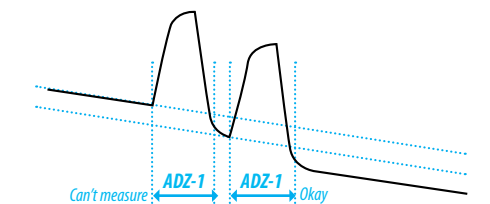

Measurement Method

The OTDR connects to the DUT with a launch lead, which is a standard patch cord with suitable connectors on both ends. This ensures that the first event in the DUT can be quantified. If a launch lead is not used, the high reflection from the OTDR's internal connector masks the actual reflectance and attenuation of the DUT.



The correct parameters for the measurement of the DUT are put into the OTDR. These parameters include the IOR, backscatter, helix factor, pulse width, measurement distance, and acquisition time. The importance of accurate settings for IOR, backscatter, and helix factor is explained above. Other important settings include the following:

- **Pulse width:** A smaller pulse width yields a higher measurement resolution but works over a shorter distance and vice versa.
- **Measurement distance:** This should be set as close as possible to the actual network distance. If it is set too short, the far end of the network may not be tested. If set too long, the resolution of the network under test will be low.
- **Acquisition time:** A test with a short acquisition time will result in a higher noise level. However, a longer acquisition time will require longer work hours for testing purposes.

If the optical network's parameters are not known, most modern OTDR have automatic detection settings. The OTDR tests the network starting with a short pulse width and incrementally increases the pulse width until it detects an end-of-fiber reading. It automatically adjusts the pulse width and measurement distance setting to best suit the DUT conditions.

An OTDR trace will indicate any events detected in the DUT. There may be discrepancies between the OTDR trace result and the actual components in the DUT. This may be due to (1) high-quality connectors with low reflectance being recognized as splices rather than connectors or (2) undetected events, such as low attenuation splices.

In PON systems where splitters are installed in the OSP, the use of a short pulse width (e.g., 5 ns) will not produce a readable result after the splitter due to the high loss. A 1:16 splitter will cause about a 14 dB attenuation. This will usually cause the OTDR trace to drop below the OTDR noise floor. However, using a larger pulse width, such as 275 ns, will yield a lower resolution reading for the portion of the network before the splitter, thus potentially missing events or merging closely spaced events.

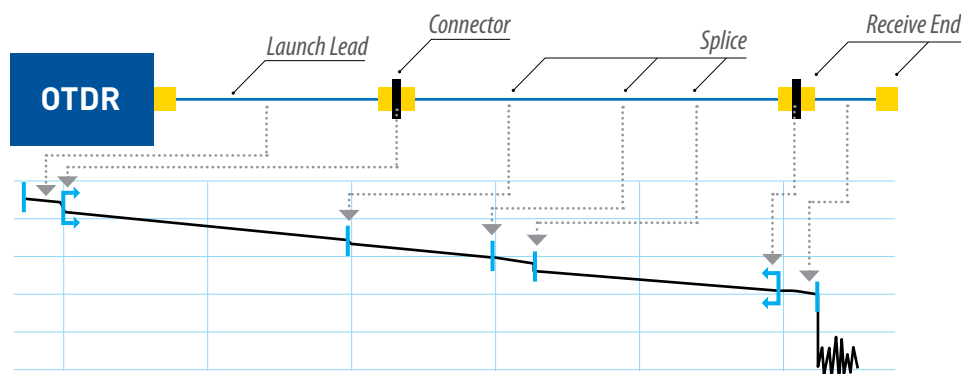

One possible method for testing such a network is to use a short pulse width (e.g., 5–10 ns) to identify all event locations up to point of the splitter, then perform a second test using a medium pulse width (50–100 ns) for increased dynamic range to measure splitter loss while maintaining good resolution. Finally, a third test is performed using a pulse width of 275 ns or higher to test past the splitter to the end of the network. Further tests may be required if the dynamic range is

insufficient to yield a noise-floor margin of at least 6 dB. When all tests are complete, the information from the multiple OTDR traces must be analyzed and tabulated into a report. Such testing requires skill and time. In addition, tests are usually performed using the 1,310 nm and 1,550 nm wavelength to detect macrobends, which results in longer test times.

Optical Continuous Wave–Based Measurement

Overview

OCWR relies on a basic power-meter measurement of the launch power (assuming no DUT) as a base reference and compares this to the optical power reflected back to the source. For a backreflection meter, this method is usually used to measure the ORL of patch cords. For an Optical Line Test Set (OLTS), this method can be used to measure the total ORL and attenuation of a network.

Limitations

The OCWR method cannot differentiate between Rayleigh backscatter and Fresnel backreflection. If a patch cord tested with a backreflection meter yields a low ORL result, it is highly likely that the connector is faulty—although there is a possibility that the cord itself has been manufactured with microbends.

When using test instruments that employ the OCWR method, the network or component under test must be isolated from the rest of the optical network to prevent any backscatter or reflection from

events further down the link. This means that the OCWR method cannot be deployed on a live network.

To isolate the DUT from unwanted reflections, the optical fiber must be terminated at two different points. The two commonly used termination methods are the mandrel wrap and the index-matching gel or block. Each of these methods have limitations, as shown in the table below. The difference in backreflection between the two termination points is calculated to give the DUT backreflection level.

Mandrel Wrap	Index-Matching Gel	Index Matching Block
Not applicable to non-bendable structures such as hardened cables or cords	Matching gel might leave a residue on the polished connector end face	Not suitable for connectors with guide pins, such as MPOs, or where the connector end-face is not accessible, such as E2000.
Bend-insensitive fiber does not exhibit bend loss	Backscatter of the fiber length between the reflective event and the far end of the cable might amplify reflections	
Cannot optically isolate far end through bending.	Limited effectiveness in terminating reflections	
Manual process to isolate far end and highly depends on the technician's skill level		

Multimode fiber cannot be terminated effectively using mandrel wraps, as the wraps can introduce bend loss but not totally terminate the fiber. In most cases, the use of an index-matching gel or block is the only solution. An index-matching gel or block matches the IOR of fiber, which causes light to diffuse out of the fiber core rather than

experience Fresnel backreflection. However, index-matching gels are not as effective as mandrel wraps, and they can never fully prevent backreflection. Multiple measurements are usually required, with the highest return loss measurement result taken as an approximation of the potential result if a mandrel wrap is used.

Measurement Method

A reference patch cord is terminated to the light source of the OCWR. The end of the reference patch cord is coiled around a mandrel to increase attenuation and prevent detection of any Fresnel backreflection from the open end of the connector. The mandrel is applied as close to the end connector as possible. The detected ORL is set as a base reference.

A DUT is then connected to the reference patch cord. The DUT is then coiled around a mandrel as close to the connection point as possible. This reduces the optical fiber backscatter that might affect the connector reflectance reading. The OCWR displays the ORL of the DUT with respect to the base reference value.

A Master Patch Cord is usually used as the reference patch cord. A master patch cord is manufactured with very strict quality standards to ensure repeatability of measurement results regardless of the test equipment type, manufacturer, operator, or the test's duration. The connector interface of the master patch cord has near-perfect specifications on the end-face radius of curvature, apex offset, and fiber protrusion or undercut.

ORL A

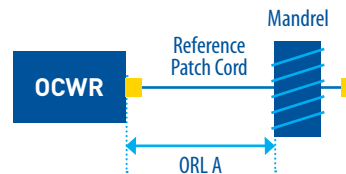

ORL B

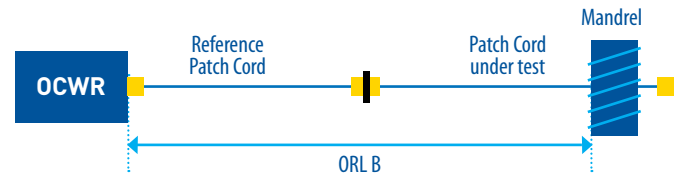

$$\text{ORL of Patch Cord under test} = \text{ORL B} - \text{ORL A}$$

DUT

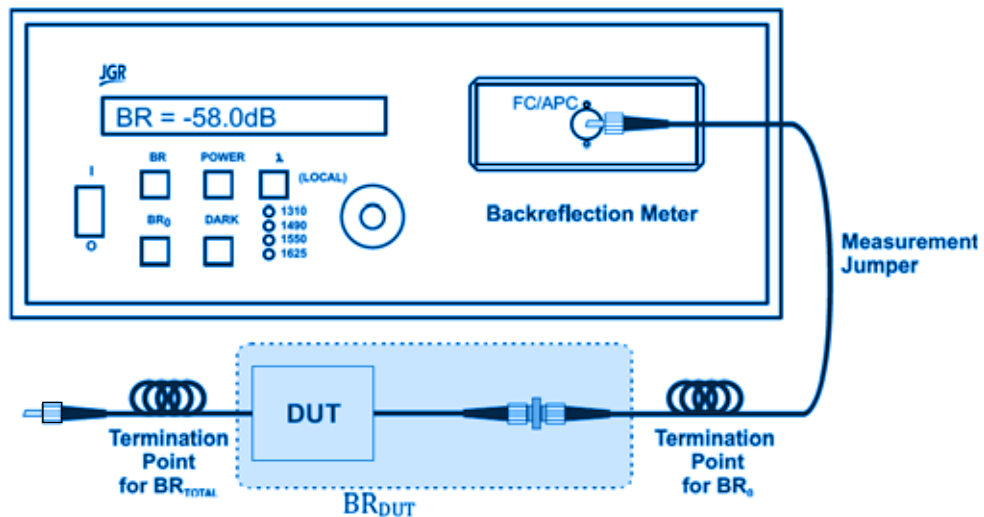

Proper testing is required to ensure high ORL readings in components and networks to maintain high-quality signal transmission. OTDR and OCWR are the two most commonly used ORL measurement methods; each method has its advantages and disadvantages. OTDR is most commonly used in OSP networks, while the OCWR method is most widely used for ORL qualification of patch cords and components.



- Suitable for short DUTs with limited backscattering impact
- Simple and faster measurement
- Limitation when testing rigid cable or bend-insensitive fibers



- Suitable for long DUT such as outside plant fiber network
- Able to characterize connectors and DUT reflectance
- Compatible with almost any type of DUT

References

1. <http://www.lightwaveonline.com/articles/print/volume-21/issue-6/technology/fiber-to-the-test-pons-installation-challenges-53905822.html>
2. <http://www.thefoa.org/tech/ref/testing/test/reflectance.html>
3. "Backreflection vs. Return Loss—What Difference Does It Make?," Mark Berezny, JGR

Acknowledgement

The development of this white paper benefited significantly from the input and support provided by our partner, JGR Optics Inc. Their feedback and guidance has provided invaluable insights, and the background information they provided has been vital to the development of this white paper. We would like to give special thanks to each member of their team for sharing their time and expertise with us.

Biography



Bernard H. L. Lee is currently the Regional Technology Director at SENKO Advanced Components. He started his career in optical communications in 2000 as a Senior Research Officer for DAVID, a European Union IST project. In 2003, he joined the R&D division at Telekom Malaysia, where he held various technical and management positions, including Head of Photonic Network Research and Head of Innovation and Communications, before joining the parent company in 2010 as Assistant General Manager of the Group Business Strategy Division, where he oversees the company's business direction. Bernard is also a member of the International Electrotechnical Commission (IEC) and the Institute of Engineering and Technology (IET), and has served on the Board of Directors of the Fiber-to-the-Home Council APAC.

www.senko.com